

# An Electric Vehicle Drive System Utilizing a Z-Source Inverter for Permanent-magnet Synchronous Motors

YHEMAN<sup>1</sup>, M PAVAN KUMAR<sup>2</sup>

<sup>1,2</sup>Professor, DEPARTMENT OF EEE  
KLR COLLEGE OF ENGINEERING & TECHNOLOGY  
BCM ROAD, PALONCHA-507115, BHADRADRI KOTHAGUDEM DIST

## Abstract

This paper presents a novel permanent-magnet synchronous motor (PMSM) drive system with bidirectional Z-By taking into account DC-link voltage boosting, a new vector-controlled scheme of the PMSM drive is developed as a zero-voltage source inverter (ZSI) for electric vehicles. Instead of using field weakening control to achieve a broad speed range in PMSM, ZSI characteristics are employed for DC-link voltage control in a single stage. Sabre simulations have been used to confirm the system's viability and efficiency.

Synchronous motors with a permanent magnet, electric cars, Z-Source inverters, and voltage increases of 1 are the focus here.

## Introduction

Research on electric vehicles (EV), which are much more environmentally friendly than conventional automobiles, is gaining traction as a result of the skyrocketing price of oil and the rising concern about global environment problems. In order for EVs to be practical, their drive systems need to be able to go from a complete stop to high speeds. Permanent magnet synchronous motors (PMSM) are gaining popularity despite the fact that vehicles have historically been propelled by a wide variety of motor topologies [1-2]. Since these motors can only weaken their field by a small amount, they have a short constant-power region by design. There are two primary control schemes that have been discussed in the literature for expanding the speed range. In the high-speed region, field weakening control is the most common, but it requires more current to decrease the motor's magnet flux. The other is a technique for regulating voltage in a DC connection. To increase the DC-link voltage beyond the rated speed, a PMSM drive system with a boost converter in series with the PWM inverter has been proposed in references [3], [4]. However, this two-stage system increases not only the complexity of circuitry and control but also the cost and the space needed. Meanwhile there are various flaws in the typical voltage source inverter. Z-Source inverters (ZSIs) are proposed as a competitive alternative to traditional inverter topologies [5-7]. ZSIs are single-stage power converters. Due to the evident inherent benefits such as both voltage buck and boost capabilities, it has been used for numerous applications, such as fuel cell energy conversion systems [5] and induction motor drives [6]. This study presents a full PMSM drive system that makes use of bidirectional ZSI. Then, the PMSM drives' voltage-boosting control method and modified vector-controlled scheme are introduced, followed by the

ZSI's steady-state working concept. Simulation studies in Saber are used to confirm the validity of the proposed system.

## Way Inverter That Uses Z-Sources

Battery pack, impedance network, conventional voltage-source inverter, and permanent magnet synchronous motor (PMSM) are shown in Fig.1 as components of the proposed drive system. Two identical inductors and two identical capacitors are linked in a precise way to form the impedance network, which has the appropriate characteristics. The extra switch S7 is fitted antiparallel to the input diode to remove the unwanted operating modes induced by inductor current discontinuous, and permits the system have the ability of bidirectional power flow.

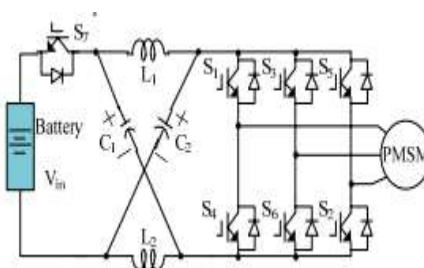

Fig. 1 Topology with bidirectional ZSI for PMSM drive

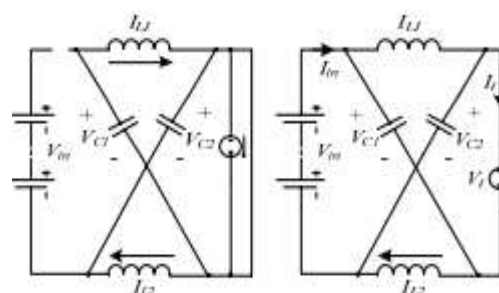

Fig. 2 Equivalent circuits of ZSI

From the two equivalent circuits of the ZSI shown in Fig.2, we have

$$I_{L1} = I_{L2}, \text{ and } V_{C1} = V_{C2}$$

As described in [5], in the steady state, the operating principle can be expressed as follows:

$$\begin{cases} B = 1 / (1 - 2D_0) \\ V_{dc} = V_c / (1 - D_0) = BV_m \\ V_c = (1 - D_0)BV_m \\ \overline{V_{dc}} = D_0[0 + (2V_c - V_m)(1 - D_0)] = V_c \end{cases}$$

Where is the shoot-through time duty ratio? is the boost factor resulting from the shoot-through zero state. is the dc source voltage. is the peak DC-link voltage across the inverter bridge.  $D_0$  B in V dc V dc V is the average dc-link voltage, which equals to the capacitor voltage. In order to use shoot-through vector to control the dc boost of this inverter, PWM methods are modified and discussed comprehensively: simple, maximum boost, maximum constant boost control, and modified SVPWM scheme (MSVPWM). SVPWM technique is possibly the best among all the PWM techniques for variable speed applications because of lower current harmonics and a higher modulation index. So, the MSVPWM [7] scheme is adopted in this paper.

## Drive System

### Voltage and Current Limits [8]

For a PMSM, the steady state voltage equation in the rotor reference frame is

$$\begin{bmatrix} v_{ud} \\ v_{uq} \end{bmatrix} = \begin{bmatrix} R + pL_d & -\omega_r L_q \\ \omega_r L_d & R + pL_q \end{bmatrix} \begin{bmatrix} i_{ud} \\ i_{uq} \end{bmatrix} + \begin{bmatrix} 0 \\ \omega_r \lambda_{pm} \end{bmatrix}$$

where  $v_{ud}$ ,  $v_{uq}$ ,  $i_{ud}$  and  $i_{uq}$  :

are d- and q-axis voltages and currents respectively,

$$R, L_d, \text{ and } L_q$$

Lb are motor armature resistance, d- and q-axis inductances respectively, and  $\omega_e \lambda_{pm}$  are electrical angular frequency and PM flux linkage respectively. In practice, considering the motor maximum line current amplitude and maximum available voltage, one can form the following constraints s ma

$$\begin{aligned} i_{ud}^2 + i_{uq}^2 &\leq i_{s,max}^2 \\ v_{ud}^2 + v_{uq}^2 &\leq v_{s,max}^2 \end{aligned}$$

Substituting (2) into (3), the derivative operator becomes zero in the steady state, and neglecting the armature resistance drop for high-speed operation, one can obtain an equivalent voltage constraint as

$$(L_q i_{uq})^2 + (L_d i_{ud} + \lambda_{pm})^2 \leq v_{s,max}^2 / \omega_e^2$$

Generally, as the DC-link voltage of inverter keeps constant, will also keep constant. As is larger than the rated speed of motor, a field weakening strategy should be used to provide the motor a high-speed operation as the constant is used. However, the corresponding current amplitude will increase such that the copper loss will increase. From (4), in this paper, another strategy is used to provide the motor a high-speed operation by boosting the as is increased. s max v ) s max v  $\omega_e$  Having considered the characteristics of battery, the battery current is limited to the value. This value corresponds to the DC-link current when the motor current is the rated current. Because of this battery current limit, the system operates with constant torque within the rated speed and operates with constant power above the rated speed. The maximum output torque is defined as the following equation

$$T_{max} = E_{BT} I_{BT,max} / (\omega_e \eta)$$

Where EBT is the battery voltage, and  $\eta$  is the convention efficiency.

## Control Scheme

Fig.3 shows the control scheme of PMSM drive system with bidirectional ZSI for EV

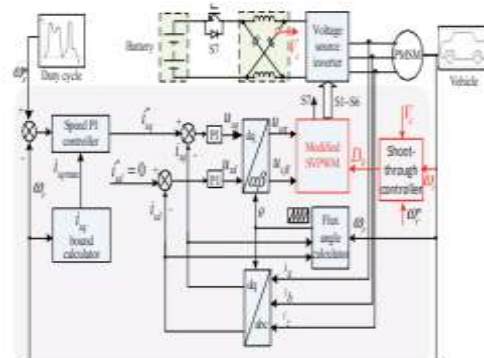

Fig.3 Control scheme of PMSM drive system with ZSI for EV

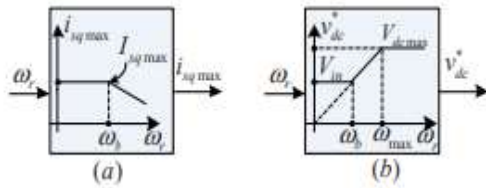

Fig. 4. (a) Functional diagram of sq i bound calculator. (b) Functional diagram of DC-link voltage command The sq i bound calculator functional block diagram of Fig.3 shows in Fig. 4(a).

The input parameter is the rotor speed and the output is maximum amplitude of q-axis current . In the speed PI controller, it will limit the motor maximum line current amplitude in the zero d-axis current control mode such that the battery current will not exceed its limit. sq max i The DC-link voltage command block is shown in Fig. 4(b). When the rotor speed is less than the rated speed , the ZSI works without boost and the DC-link voltage command equals to the input voltage. The v increases above the rated voltage as the motor in the high-speed operation. or  $\omega_b * dc * dc v$  the DC-link voltage is unsuitable to select as a feedback signal due to the shoot-through state of ZSI. By equation (1), the Z-source capacitor voltage can be boosted by controlling the shoot-through time duty ratio . So, in this paper, is selected as feedback signal to control indirectly. In order to overcome the nonlinear problem between and , a linear capacitor voltage controller [9] is adopted. The task of shootthrough controller in Fig.3 is to generate .

**Simulation Results Table 1. Values of parameters**

Component	Parameter	Value
PMSM	Rated output power	17 kW
	Rated speed	50 rad/s
	Rated torque	340 N.m
	Armature resistance (R)	0.4375 Ω
	Pole number	8
	d-axis inductance ( $L_d$ )	8 mH
Battery	q-axis inductance ( $L_q$ )	8.5 mH
	Flux of field	0.8 Wb
	Rated voltage ( $E_{BR}$ )	410 V
Transmission system	Rated capacity	100 Ah
	ratio efficiency	1:2 0.9
Z-source network	Inductor	36.5 μH
	Capacitor	300 μF
Vehicle	Gross mass	990 kg
	Frontal area	1.7 m <sup>2</sup>
	Rolling Resistance Coefficient	0.015
	Radius of wheels	0.287 m
	Aerodynamic drag Coefficient	0.3

The effectiveness and the dynamics of the proposed drive system for EV are investigated extensively in simulation using Sabre. The values of the system parameters are listed in table 1. The system is operated in different operation modes, as shown in Fig.5

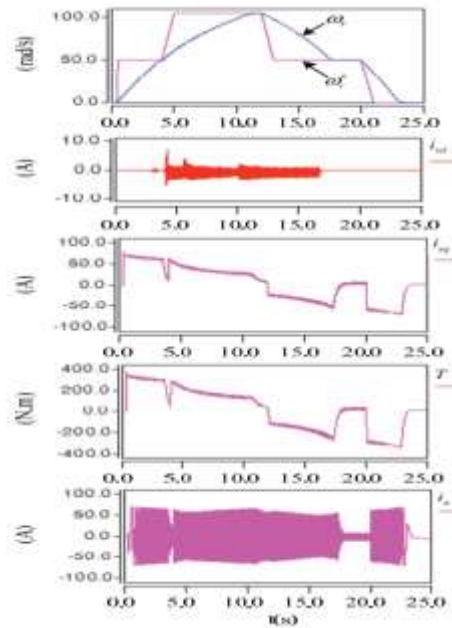

Fig. 5. Transient waveforms for PMSM driven by ZSI

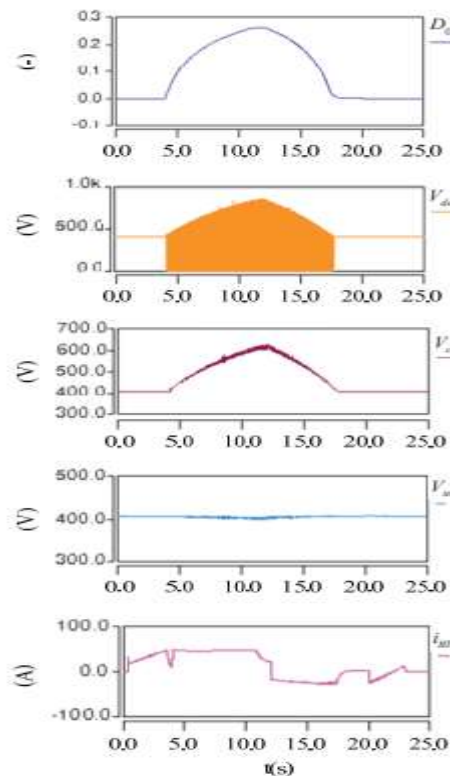

Fig. 6. Characteristic of ZSI operation

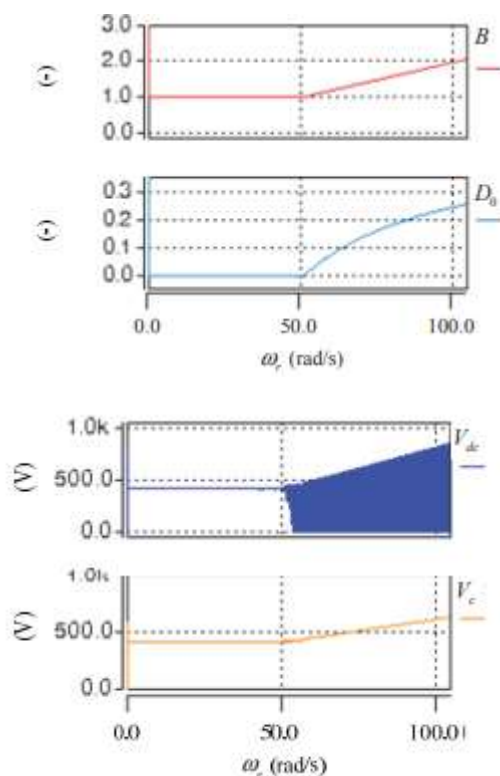

Fig. 7 (a) Boost factor and shoot-through time duty ratio versus speed characteristics (b) DC-link voltage and capacitor voltage versus speed characteristics F per loss by the current is generated.

- In the regenerative braking mode, from Figs.5 - 7, one finds the following,
- The d-axis current keeps zero above the rated speed. That is, the drive system does not need the current to reduce the magnet flux of the motor. As a result, there is no positive additional cop BT i. That is, the system has the ability of bidirectional power flow.
- As in the rated speed operation, the ZSI works without shoot-through and the DC-link voltage equals to the input voltage.
- When the motor speed is increasing or decreasing above the rated speed, the ZSI is in the voltage boost mode. The DC-link voltage is boosted proportional to the speed by Fig.4. And the results of B , D<sub>0</sub> , c V coincide with the analytical calculation by equation (1).

## Conclusion

A PMSM drive system incorporating bidirectional ZSI has been presented in this paper. In order to extend the speed range of the PMSM and decrease the current amplitude in the high-speed region, the ZSI provides an increasing DC-link voltage by gating on both the upper and lower switches of the same phase leg, as the rotor speed is greater than the rated speed. Hence, the reliability of the

inverter is greatly improved because the shoot through can no longer destroys the circuit. The drive system can provide a low cost and highly efficient single stage structure for reliable operation. In addition, the characteristics of the PMSM driven by bidirectional ZSI are analysed. The simulated results are performed to verify the proposed system.

## References

- [1] Z. Q. Zhu and D. Howe. *Electrical Machines and Drives for Electric, Hybrid, and Fuel Cell Vehicles*. IEEE Proceedings., vol. 95, no. 4, pp. 746-765, Apr. 2007.
- [2] C. C. Chan. *The State of the Art of Electric, Hybrid, and Fuel Cell Vehicles*. Proceedings of the IEEE, vol. 95, pp. 704-718, 2007.
- [3] K. Yamamoto, K. Shinohara, T. Nagahama. *Characteristics of permanent-magnet synchronous motor driven by PWM inverter with voltage booster*. IEEE Trans. On Ind. Appl., Vol. 40, no. 4, pp.1145-1152, 2004.
- [4] K. Yamamoto, K. Shinohara and S. Furukawa. *Permanent Magnet Synchronous Motor Driven by PWM Inverter with Voltage Booster with Regenerating Capability Augmented by Double-Layer Capacitor*. IEEJ Trans. IA, Vol. 126, No.5, pp. 639-645, 2006.
- [5] Peng F.Z.. *Z source inverter*. IEEE Trans. Industry Applications, vol. 39, no. 2, pp. 504-510, March/April 2003.
- [6] F. Z. Peng, X. M. Yuan, X. P. Fang, and Z. M. Qian. *Z-source inverter for adjustable speed drives*, IEEE Power Electron. Lett., vol. 1, no. 2, pp. 33-35, Jun. 2003.
- [7] JINGBO L., JIANGANG H., LONGYA X.. *A modified space vector PWM for z-source inverter-modeling and design*. Proc. IEEE Electrical Machines and Systems. Conf., 2005, pp. 1242-1247
- [8] D. W. Novotny and T. A. Lipo. *Vector Control and Dynamics of AC Drives*. New York: Oxford Univ. Press, 1997, ch. 9.
- [9] T. Quang-Vinh, et al.. *Algorithms for Controlling Both the DC Boost and AC Output Voltage of Z-Source Inverter*. IEEE Transactions on Industrial Electronics, vol. 54, pp. 2745-2750, 2007.